

CHIRP

Upgrade Your Sounder to a Serious Fishfinding Machine!
Only possible with the use of an AIRMAR broadband transducer.

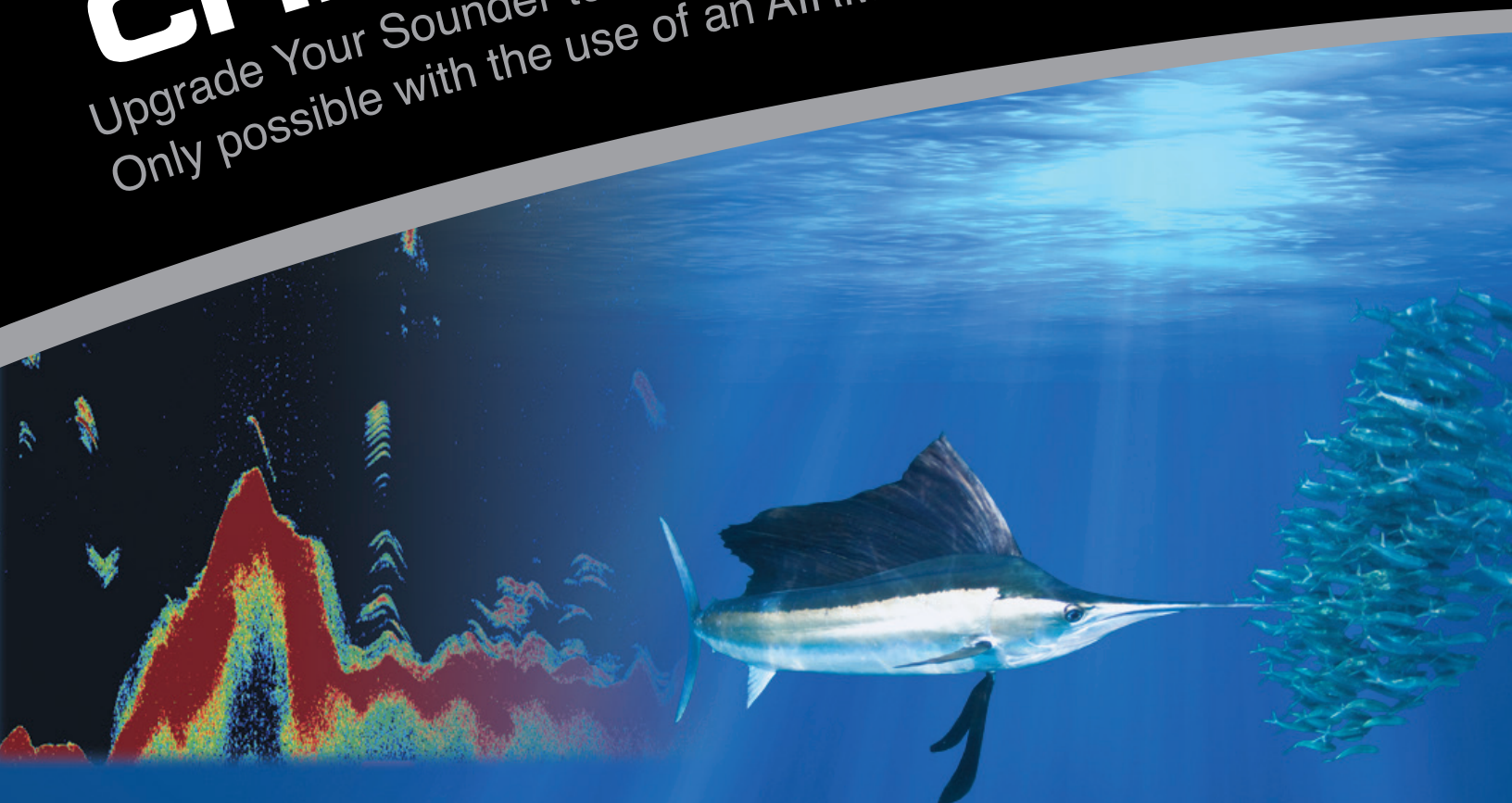

CHIRP TECHNOLOGY

- 5 to 10 times greater detail and resolution
- 10 to 1,000 times more energy on targets
- Accuracy down to 3,000 m (10,000')
- Precise separation between baitfish and game fish
- Superior performance in noisy environments
- Improved bottom tracking at high boat speeds

**DEEPER.
BROADER.
CLEARER.**

GAME CHANGING TECHNOLOGY.

AIRMAR[®]
TECHNOLOGY CORPORATION

Sensing Technology



Pocket / Keel-Mount

Screen shot courtesy of Simrad[®].

Broadband / CHIRP Transducers

When Your Living Depends on Finding Fish...

Rely on Airmar's new broadband transducers for the ultimate fishing mission. Whether you're a commercial fisherman, charter captain, or tournament angler, there's a new game in town! CHIRP transducers enable bottom detection down to 3,000 m (10,000') with 5 to 10 times greater detail and resolution so precise it's possible to distinguish between individual baitfish, game fish, and underwater structures. One transducer delivers up to 117 kHz of total bandwidth in just one installation, saving customers time and money.

Airmar...it's what's under your boat.

The CHIRP Difference

Traditional marine fishfinders operate at discrete frequencies such as 50 kHz and 200 kHz, use relatively short-duration transmit pulses, and use narrowband sonar transducers. In contrast, CHIRP (compressed high-intensity radar pulse) uses a precise sweep pattern of many frequencies within a long-duration transmit pulse from a broadband transducer, so the equivalent sound energy transmitted into the water is 10 to 1,000 times greater than a conventional marine fishfinder. The echo energy returning to the transducer, superior to that generated by a conventional transducer, is then processed by the fishfinder's DSP (digital signal processing) computer and displayed in ultra-sharp detail on the display. The combination of CHIRP, a broadband transducer, and the fishfinder's DSP, results in dramatically better fish and bottom detection, superior depth capability, and significantly better performance at speed.

Does YOUR Fishfinder CHIRP?

Only CHIRP/Spread Spectrum sounders using Airmar broadband transducers can operate as a CHIRP fishfinder system. When Airmar's new transducer is paired with a broadband fishfinder, the result is 5 to 10 times greater sensitivity and performance than current fishfinder technology. Packed with exclusive technology like Transducer ID® and newly engineered piezoceramic elements, Airmar transducers are über sensitive and designed to automatically sweep frequency bands from 28 kHz to 210 kHz with no tuning necessary. As a result, all targets detected in the entire bandwidth will be seen on the display rather than only what is identified in traditional frequencies at 50 kHz and 200 kHz.

Airmar's complete line of twenty-four (24) CHIRP transducers are available in seven (7) different mounting options to accommodate almost any hull design. CHIRP transducers are available at Gemeco Marine Accessories www.gemeco.com and Airmar EMEA www.airmar.com/emea. Visit www.AIRMAR.com for a list of CHIRP-ready transducers.

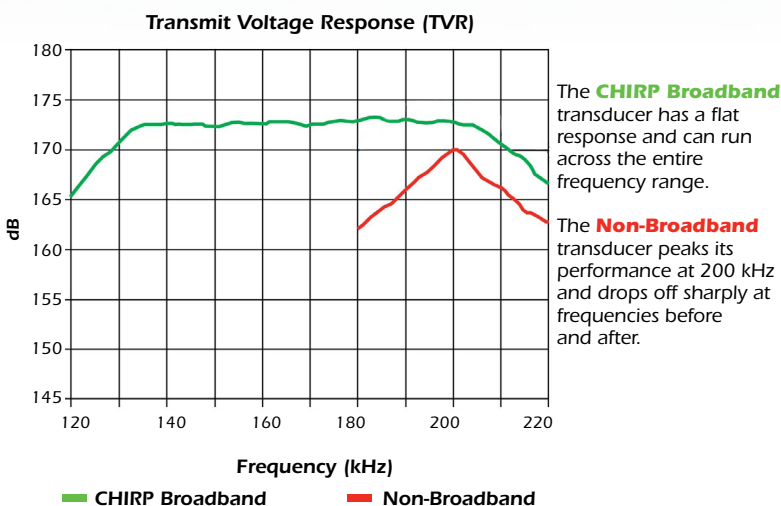

Operation Under High-Frequency CHIRP Mode.

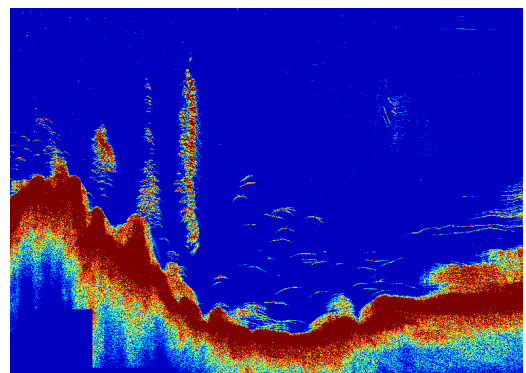

Screen shot courtesy of Garmin®.

CORE

Pocket / Keel-Mount

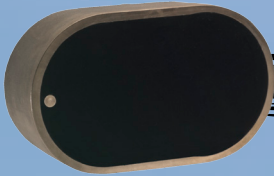

PM265LH (Low & High-Frequency)

MSRP
\$1,650.00

- Depth & fast-response water-temperature sensor
- Low—CHIRPS from 42 kHz to 65 kHz
25° to 16° beamwidth (port-starboard)
- High—CHIRPS from 130 kHz to 210 kHz
10° to 6° beamwidth
- 103 kHz of total bandwidth from one transducer
- Covers popular fishing frequencies of 50 and 200 kHz plus everything else in the bandwidth
- Fishing Profile: Commercial and recreational inshore and offshore fishing (deep-water canyon and sea-mount tracking)
- Bronze transducer housing
- Hull Type: Fiberglass only

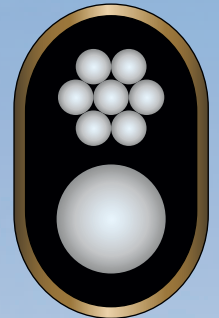

8-Internal
Broadband Ceramic
Assemblies

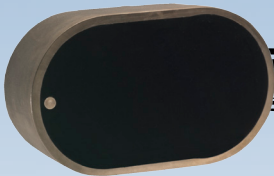

PM265LM (Low & Medium-Frequency)

MSRP
\$1,835.00

- Depth & fast-response water-temperature sensor
- Low—CHIRPS from 42 kHz to 65 kHz
25° to 16° beamwidth (port-starboard)
- Medium—CHIRPS from 85 kHz to 135 kHz
16° to 11° beamwidth
- 73 kHz of total bandwidth from one transducer
- Covers popular fishing frequencies of 50, 88, and 107 kHz plus everything else in the bandwidth
- Fishing Profile: Commercial and recreational inshore and offshore fishing (deep-water canyon and sea-mount tracking)
- Bronze transducer housing
- Hull Type: Fiberglass only

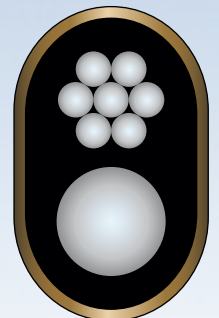

8-Internal
Broadband Ceramic
Assemblies

Medium-frequency benefits include the ability to sound deeper than the high-frequency, along with better target resolution than the low-frequency.

DIMENSIONS

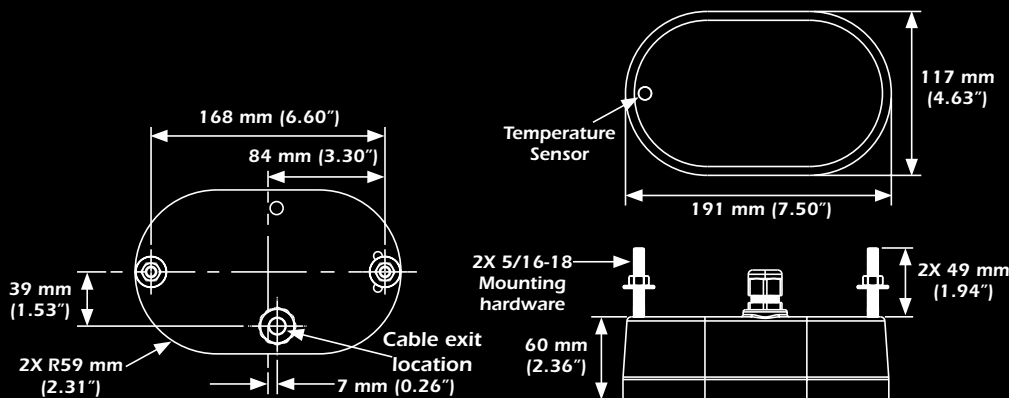

HARD-CORE

Pocket / Keel-Mount



MSRP
\$3,580.00

PM111LH (Low & High-Frequency)

- Depth & fast-response water-temperature sensor
- Low—CHIRPS from 38 kHz to 75 kHz
19° to 10° port-starboard beamwidth (10° to 5° fore-aft)
- High—CHIRPS from 130 kHz to 210 kHz
8° to 4° beamwidth
- 117 kHz of total bandwidth from one transducer
- Covers popular fishing frequencies of 38, 50, and 200 kHz plus everything else in the bandwidth
- Fishing Profile: Commercial and recreational in-shore and offshore fishing (deep-water canyon and sea-mount tracking)
- Urethane transducer housing
- Hull Type: Fiberglass only

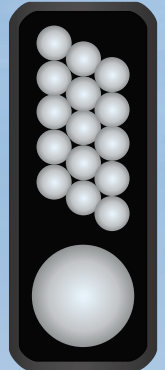

16-Internal
Broadband Ceramic
Assemblies



MSRP
\$3,825.00

PM111LM (Low & Medium-Frequency)

- Depth & fast-response water-temperature sensor
- Low—CHIRPS from 38 kHz to 75 kHz
19° to 10° port-starboard beamwidth (10° to 5° fore-aft)
- Medium—CHIRPS from 80 kHz to 130 kHz
13° to 8° beamwidth
- 87 kHz of total bandwidth from one transducer
- Covers popular fishing frequencies of 38, 50, 88, and 107 kHz plus everything else in the bandwidth
- Fishing Profile: Commercial and recreational inshore and offshore fishing (deep-water canyon and sea-mount tracking)
- Urethane transducer housing
- Hull Type: Fiberglass only

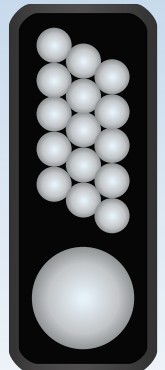

16-Internal
Broadband Ceramic
Assemblies

Medium-frequency benefits include the ability to sound deeper than the high-frequency, along with better target resolution than the low-frequency.

DIMENSIONS



ELITE

Pocket / Keel-Mount

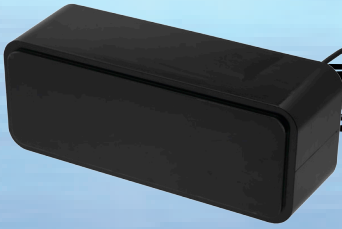

MSRP
\$3,780.00

CM599LH (Low & High-Frequency)

- Depth & fast-response water-temperature sensor
- Low—CHIRPS from 28 kHz to 60 kHz
23° to 9° port-starboard beamwidth (11° to 5° fore-aft)
- High—CHIRPS from 130 kHz to 210 kHz
8° to 4° beamwidth
- 112 kHz of total bandwidth from one transducer
- Covers popular fishing frequencies of 28, 38, 50, and 200 kHz plus everything else in the bandwidth
- Fishing Profile: Recreational and commercial inshore and offshore fishing (deep-water canyon and sea-mount tracking)
- Epoxy transducer housing
- Hull Type: Fiberglass only

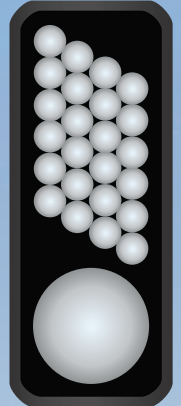

25-Internal
Broadband Ceramic
Assemblies



MSRP
\$3,980.00

CM599LM (Low & Medium-Frequency)

- Depth & fast-response water-temperature sensor
- Low—CHIRPS from 28 kHz to 60 kHz
23° to 9° port-starboard beamwidth (11° to 5° fore-aft)
- Medium—CHIRPS from 80 kHz to 130 kHz
13° to 8° beamwidth
- 82 kHz of total bandwidth from one transducer
- Covers popular fishing frequencies of 28, 38, 50, 88, and 107 kHz plus everything else in the bandwidth
- Fishing Profile: Recreational and commercial inshore and offshore fishing (deep-water canyon and sea-mount tracking)
- Epoxy transducer housing
- Hull Type: Fiberglass only

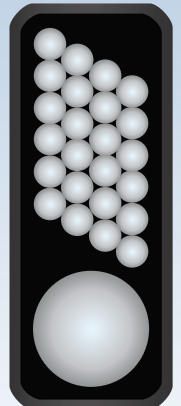

25-Internal
Broadband Ceramic
Assemblies

Medium-frequency benefits include the ability to sound deeper than the high-frequency, along with better target resolution than the low-frequency.

DIMENSIONS

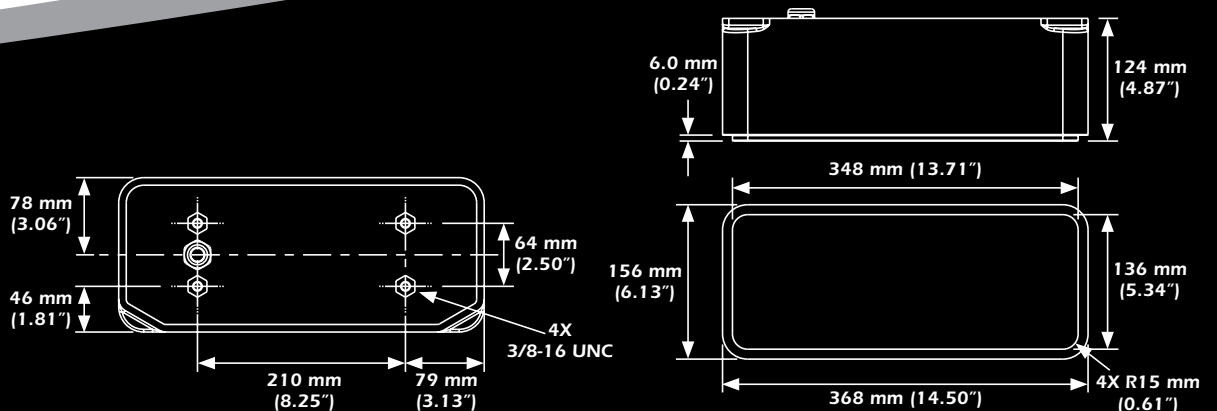

Technical Information

Advantages of Pocket / Keel-Mount Transducers

Maximum performance, no drag, and increased fuel efficiency. Ideal for sportfishing vessels, high-speed powerboats, or smaller boats where installation of a high-performance transducer is not possible due to trailer, lift, or hull limitations.

Pocket and Keel-Mounted transducers are installed flush to the hull. A flush installation positions the transducers face parallel to the waterline resulting in a beam that is vertically oriented for maximum echo return and incredible performance at speed. Optimum performance is achieved because the face of the transducer is in direct contact with the water, providing the best sensitivity. There is no drag because the transducer is installed either flush into a flat spot located along the keel or into a custom pocket. Boat builders can create a detail in their mold so that a pocket is formed along the keel. The transducer is then inserted into the pocket from the outside of the hull allowing future upgrades without altering the finished hull. Aftermarket installation requires routing a hole in the hull and glassing the transducer flush to the running surface. Running performance is maintained and prop and intake cavitations are eliminated.

See *Guide to Transducer Technology* to compare Pocket / Keel-Mount, In-Hull, Thru-Hull, and Transom-Mount options. www.airmar.com

Unique Transducer ID®

Airmar's Transducer ID feature measures and stores the operating parameters for each transducer. This enables the fishfinder to automatically configure itself to the transducer being used. The embedded microcontroller continuously monitors ceramic operating temperatures inside the transducer, enabling closed loop control of power output. The transducer's profile can be presented on the display showing beamwidth coverage as a function of frequency. Stored data also assists with troubleshooting, warranty or any required information about the transducer.

Quality "Q" Value

Q is a measure of bandwidth and the rise and fall times of target echoes. Airmar Q values range from 1.6 to 30, depending on the model. Competitive transducers have an average Q of 25 to 30. The lower the "Q" number, the less ringing in the transducer and the better the performance—improved individual fish separation along with bottom imaging in rapidly changing water depths such as ledges and offshore canyons.

All Airmar CHIRP transducers have a Q of 3 or less.

Model	Q / Bandwidth		Roundtrip Sensitivity*	
	LF	HF	LF	HF
B45 (baseline)**	28 / 1.8 kHz	30 / 6.7 kHz	1 times	1 times
CM260**	9 / 6 kHz	8 / 25 kHz	250 times	50 times
PM265	2.2 / 23 kHz	2 / 80 kHz	1,000 times	120 times
R111	1.6 / 37 kHz	2 / 80 kHz	4,100 times	225 times
CM599	1.6 / 37 kHz	2 / 80 kHz	6,100 times	240 times

*All roundtrip sensitivity data is based on the Figure of Merit (FOM) and the transducer bandwidth relative to the B45 model.

**Commonly used non-CHIRP transducers.

See *Theory of Operation* for a complete understanding of transducer terminology and operation. www.airmar.com



www.airmar.com

©Airmar Technology Corporation

PocketKeelMountCHIRP_BR_rD 01/13/16

As Airmar constantly improves its products, all specifications are subject to change without notice. All Airmar products are designed to provide high levels of accuracy and reliability, however they should only be used as aids to navigation and not as a replacement for traditional navigation aids and techniques. Xducer ID® is a registered trademark of Airmar Technology Corporation. Other company or product names mentioned in this document may be trademarks or registered trademarks of their respective companies, which are not affiliated with Airmar.